



Consultation
on the Proposed Amalgamation of
Ysgol Babanod Glan y Mor
and
Ysgol Iau Pendorlan
Colwyn Bay, Conwy

Contents

		Page
1	Description and Benefits of the Proposal	3
1.1	The Proposal to Amalgamate the 2 Existing Schools	4
2	Details of the Affected Schools	6
2.1	Ysgol Babanod Glan y Mor	6
2.2	Ysgol Iau Pendorlan	7
2.3	Effect on Staff	8
2.4	Admission Arrangements	8
2.5	Catchment Area	9
3	Quality & Standards in Education	9
3.1	Curriculum	9
3.2	ESTYN Inspections	9
4	Finance	10
5	Condition of School Buildings	10
6	Community Impact	11
6.1	Community Use of School Facilities	11
6.2	Out of School Childcare	11
7	Transport Impact	12
8	Language Impact	12
9	Equality Impact	14
10	Children's Workshop	17
11	Consultation	18
	Feedback Form	19

1. Description and Benefits of the Proposal

Through its Primary School Modernisation Programme Conwy County Borough Council has been reviewing current pupil numbers, equality of funding for pupils and the fitness for purpose of current school buildings across the Authority. The Local Authority has been engaging with parents, Governors, staff and communities in order to explain the current position and is proposing to establish a Community Primary School in Colwyn Bay. It will be established through the amalgamation of Ysgol Babanod Glan y Mor and Ysgol Iau Pendorlan on their current sites; which will be developed through the Welsh Government's 21st Century Schools Programme in order to accommodate and provide improved facilities for both sets of pupils from the current schools Foundation Phase and Key Stage 2. The purpose of this consultation is to establish the views of the community, potential users and other important stakeholders.

The consultation is on the basis that, if agreed, the amalgamated school will open in September 2015. Proposals brought forward by the maintaining Local Authority will require the determination by the Executive of the Local Authority in all cases; meaning that if any formal objections that are received through the Statutory process they will be considered and determined by Conwy County Borough Council's Cabinet. Only a Local Authority objection will trigger the requirement for Welsh Ministers' approval where the Local Authority is not the proposer.

Those being consulted with are listed below:-

Name/Organisation
Parents, teachers & staff of Ysgol Babanod Glan y Mor & Ysgol Pendorlan
Governors of Ysgol Babanod Glan y Mor & Ysgol Pendorlan
Headteacher & Governors of Ysgol Llandrillo yn Rhos / Ysgol Babanod Mochdre & Ysgol Cystennin / Ysgol Babanod T.Gwynn Jones / Ysgol Iau Hen Golwyn
Church in Wales Diocese of St Asaph & Roman Catholic Diocese of Wrexham
Denbighshire County Council Education Services
Gwynedd County Council Education Services
Welsh Minister for Education & Skills
Welsh Government Schools Management and Effectiveness Division
Assembly Member & Member of Parliament representing area subject to proposals
Local Conwy Councillor for Glyn Wards
Colwyn Bay Community Councils
Estyn
Teaching & Staff Trade Unions
GWE

Taith
Police & Crime Commissioner for North Wales
Conwy CYPP
Conwy Community First
Flying Start Conwy

The consultation will take place during the period from Wednesday 8th October 2014 – Tuesday 18th November 2014 inclusive.

As part of the consultation, a meeting for Stakeholders will be held on Thursday 23rd October 2014 from 5pm at Ysgol Glan y Mor which you are invited to attend. During the meeting officers from the Council's Education Services will go through the proposal and answer questions.

A report on the outcome of the consultation will be submitted to a meeting of the Council's Cabinet on 16th December 2014.

We would like to know your views on this proposal and have suggested the ways in which you can do this at the end of this document.

1.1 The Proposal to Amalgamate the two existing Schools

At the start of Conwy's Primary School Modernisation Project there were 3 schools included in the Colwyn Bay Area, namely Ysgol Iau Pendorlan, Ysgol Babanod Glan y Mor and Ysgol Conway Road Infants.

In September 2010 Conway Road Infants and Ysgol Iau Pendorlan was under the management of one Headteacher with each school retaining their own Governing Bodies. From September 2011 the same Headteacher was managing all 3 schools until the closure of Conway Road Infants on the 31st August 2012. Upon the closure of Ysgol Conway Road Infants the majority of its pupils transferred to Ysgol Babanod Glan y Mor.

During this time discussions were held with the Headteacher and Governors to look at formally amalgamating Ysgol Babanod Glan y Mor and Ysgol Pendorlan, given that they have been managed by one Headteacher since September 2011. Following these discussions it was agreed in May 2013 by the Headteacher and Governors of both schools that proposals for a formal amalgamation of the 2 schools should go ahead.

The ESTYN inspection report from 2013 for Ysgol Babanod Glan y Mor states that *"The strategic headteacher is supported very well by the deputy headteacher. Together, they provide a clear strategic direction for the work of the school."*

Likewise, the report of Ysgol Iau Pendorlan's inspection in 2011 *"The head teacher, staff and governors share a commitment to promoting the wellbeing and happiness of pupils. There is a strong sense of common purpose that nurtures these ideals successfully."*

In September 2013 a new Headteacher was appointed to manage both Ysgol Babanod Glan y Mor and Ysgol Iau Pendorlan; the Headteacher has been working with the Governing Bodies of both schools in order to continue and develop the ethos of working closer together for the benefit of all pupils and staff.

The Proposal to amalgamate Ysgol Babanod Glan y Mor and Ysgol Iau Pendorlan will incorporate the work and commitment of the 2 current Governing Bodies and satisfies the Authority's Primary School Modernisation Strategy to amalgamate infants and juniors

schools, which in turn will secure equality of funding for pupils and reduce the number of unfilled places across the 2 schools.

The Proposal to amalgamate Ysgol Babanod Glan y Mor and Ysgol Iau Pendorlan will mean the formal closure of both schools followed by the opening of a new all-through Community Primary School across both of the current sites.

The formal amalgamation of the 2 schools also incorporates the inclusion of both Foundation Phase and Key Stage 2 Autistic Spectrum Disorder (ASD) units on the site. The ASD units will provide support to pupils and will continue to promote inclusive practises within the Authority working to the County's Strategy to meet the needs of pupils on the Autistic Spectrum continuum. The current Key Stage 2 Speech & Language Resource will also remain on the site to assist pupils with specific language difficulties, whilst promoting inclusion into mainstream schools.

The expected advantages and disadvantages of the Proposal to amalgamate Ysgol Babanod Glan y Mor and Ysgol Iau Pendorlan have been considered by Education Services and are identified in the below table.

Advantages / Benefits of the Proposal	Disadvantages / Challenges of the Proposal
There will be one Headteacher and Governing Body with a shared ethos	Staffing implications, potential staff redeployment and/or redundancies
A single set of policies with a single point of contact for parents/guardians/carers	Development of new day to day operational challenges of a new amalgamated school i.e. school layout, new uniforms, new school name etc
Continuity of education and curriculum for pupils, automatically transferring from Foundation Phase to Key Stage 2	
Greater use of facilities across the site for pupils	
Greater sense of school community for all staff, pupils and parents	

Conwy Education Services have considered any potential risks associated with the proposal to amalgamate the two schools and one risk has been identified along with the action to be taken to mitigate the risk.

Risks Associated with Proposal	Action taken to Mitigate Risk
Proposal may not be supported and approved by Conwy County Borough Council's Cabinet	Continue to keep Cabinet members updated on the progress of the Proposal and the Strategic Primary School Modernisation Programme through democratic processes

By amalgamating Ysgol Babanod Glan y Mor and Ysgol Iau Pendorlan staff can work together creating stability and a shared vision to provide a consistent and coherent learning environment and offering greater potential for improving levels of achievement within the school.

Transition points in a child's education between Foundation Phase and Key Stage 2 can be disruptive. If this transition point can be removed by the creation of an all-through school the continuity in education provision can be beneficial for pupils.

2. Details of the Affected Schools

Ysgol Babanod Glan y Mor and Ysgol Iau Pendorlan – Site Plan

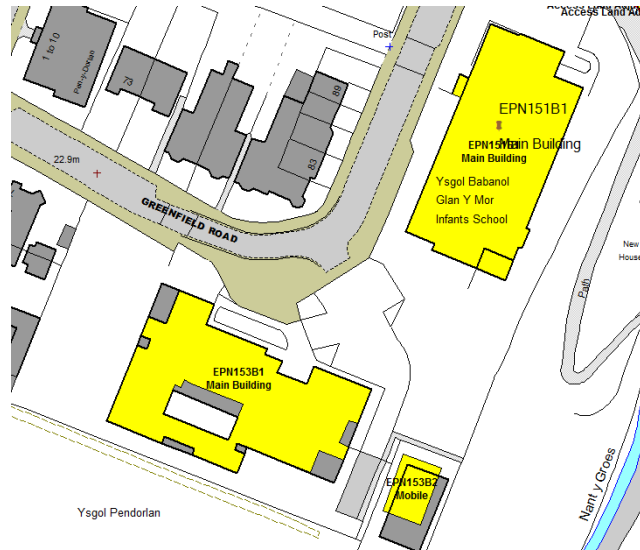

2.1 Ysgol Babanod Glan y Mor

Ysgol Babanod Glan y Mor is situated close to the centre of Colwyn Bay. It was relocated to its current site from Douglas Road in January 2002. It was built in 2002 and is a predominantly English Medium, Community School catering for children between the ages of three to seven years old.

The school has five classrooms (2 x 55m², 2 x 55.1m², 1 x 55.2m²) and a Nursery Class of 43.3m². The hall is 120.1m² and this area is also used for dining. The pupils have access to 791m² hard play area, 152m² of soft play area and a habitat area of 444m². There is also a Foundation Phase ALN unit provision at the school that use a classroom space of 55m².

Ysgol Babanod Glan y Mor - School Plan

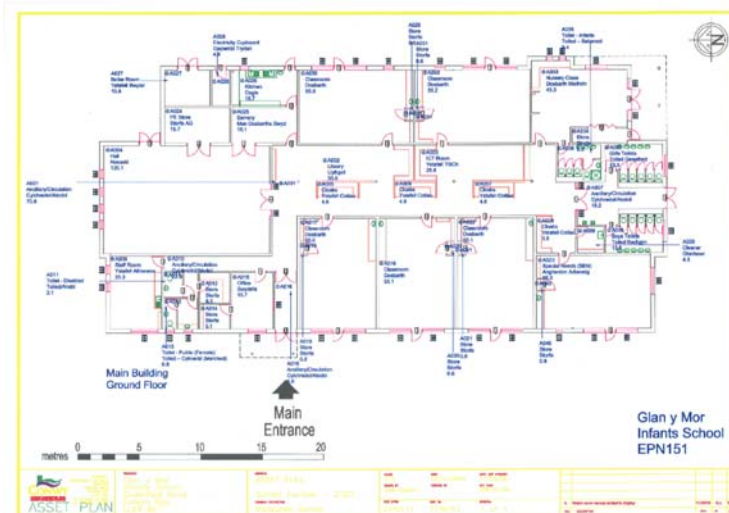

Ysgol Babanod Glan y Mor has the capacity to accommodate 145 pupils between the ages of three to seven years old.

Pupil numbers for the last 5 years

January 2010	109 (42N)
January 2011	114 (51N)
January 2012	134 (32N)
January 2013	142 (46N)
January 2014	126 (51N)

Projected pupil numbers over the next five years are expected to be:

(taken from January 2014 PLASC stats)

January 2015	133
January 2016	132
January 2017	139
January 2018	135
January 2019	136

As at January 2014 there were 126 full time children attending the school with 51 part time pupils attending the Nursery class. (Reception = 37 pupils, Year 1 = 45 pupils, Year 2 = 44 pupils).

2.2 Ysgol Iau Pendorlan

Ysgol Iau Pendorlan was built in 1980 and is a predominantly English Medium, Community School catering for children between the ages of seven to 11 years old.

The school has eight classrooms (51.8m², 53m², 3x52.7m², 56.6m², 54.6m² and 54.7m²). There are four specialist areas with a total of 134.1m².

The pupils have access to 1410m² hard play area, 3258m² of sports pitches and a habitat area of 127m². The school also has a KS2 Speech & Language ALN provision.

Ysgol Iau Pendorlan - School Plan

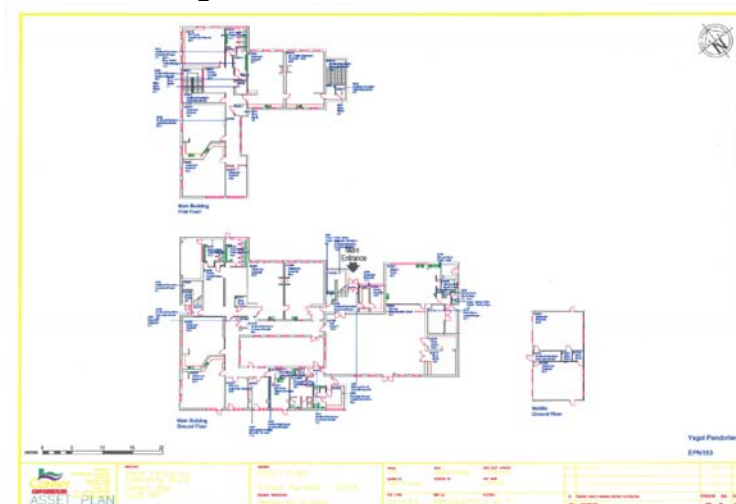

Ysgol Pendorlan has the capacity to accommodate 227 pupils between the ages of seven to 11 years old.

Pupil numbers for the last 5 years

January 2010	218
January 2011	196
January 2012	197
January 2013	183
January 2014	165

Projected pupil numbers over the next five years are expected to be:

(taken from January 2014 PLASC stats)

January 2015	171
January 2016	163
January 2017	167
January 2018	177
January 2019	177

As at January 2014 there were 165 full time children attending the school (Year 3 = 41 pupils, Year 4 = 33 pupils, Year 5 = 53 pupils, Year 6 = 38 pupils).

2.3 Effect on Staff

In the event that it is decided to amalgamate the two schools the Temporary Governing Body will work with the Headteacher and in liaison with Education HR officers in establishing staffing structure for the new amalgamated school. These proposals will provide a greater opportunity for staff development of skills over the whole primary age curriculum and potential for more specialist staffing and management structures in the all-through school.

Ysgol Babanod Glan y Mor

Following the retirement of Mr Mike Mulvaney from his post as Acting Head Teacher in July 2013, a new Head Teacher for both Ysgol Babanod Glan y Mor and Ysgol Iau Pendorlan was appointed and came into post in September 2013.

There are 7 full time Teachers at the school, including the Deputy Head, along with 3 part-time Teachers, 2 of whom manage the ALN provision at Ysgol Babanod Glan y Mor.

The teaching staff are supported by 13 Teaching Assistants across the school (4 of which are also employed as Midday Supervisors), along with 2 Administrative Assistants, a Caretaker and a Cleaner.

Ysgol Iau Pendorlan

At Ysgol Iau Pendorlan there are 9 full time Teachers including the Headteacher and 1 part time Teachers. Support to teaching staff is provided by 9 Teaching Assistants.

The school has 1 Administrative Assistant, Caretaker, 2 Cleaners and 4 Midday Supervisors.

2.4 Admissions Arrangements

Currently Ysgol Babanod Glan y Mor have an admission number of 48 and Ysgol Iau Pendorlan have an admission number of 56. The proposed Admission Number for the amalgamated school is 45 in each year group.

The admission number for Nursery places currently at Ysgol Babanod Glan y Mor is 18 and it is anticipated that the new amalgamated school will have a Nursery Admission number of 28.

Admissions arrangements for the new amalgamated school will continue to be administered by Conwy Education Services.

Teaching groups will remain within the statutory limit of 30 pupils in the Infant classes and 30 or less for Junior pupils.

2.5 Catchment Area

In the event of the proposed amalgamation of Ysgol Babanod Glan y Mor and Ysgol Iau Pendorlan there will be no changes to the existing catchment areas for the school.

Pupils will eventually transfer to the relevant Secondary Schools of Ysgol Eirias, Ysgol Y Creuddyn or Ysgol Gatholig Bendigaid Edward Jones to continue their education.

3. Quality & Standards in Education

3.1 Curriculum

If the proposal were to go ahead there would be a single school with an age range of 3 to 11 year olds. Children upon admittance to Reception would be entitled to remain at the school until the end of Year 6 when they would transfer to secondary education.

The association between parents and the school can build over a longer period of time and allow children the opportunity to interact with a wider age range of pupils benefiting their social and emotional development.

The relationship between staff and children will allow the school to better understand the needs of each pupil and provide increased flexibility and expertise in terms of delivering subjects across the whole curriculum.

Pupils currently attending Ysgol Babanod Glan y Mor and Ysgol Iau Pendorlan would be guaranteed a place within the all-through school. Parents will no longer have to re-apply for their children to be admitted to the Junior School at the end of the Foundation Phase and will provide an opportunity for continuity and a smoother transition for children from the Foundation Phase into Key Stage 2.

The ESTYN Inspection reports for schools indicates that both schools have an inclusive and caring nature which would continue to provide a safe and nurturing environment for pupils' continued development should they become an amalgamated school.

The Ysgol Babanod Glan y Mor report tells us *"The school has an inclusive ethos with a warm and caring atmosphere where individual pupils are valued and celebrated. There are very good relationships between staff and pupils. All pupils are treated equally and with respect."*

Likewise the Ysgol Iau Pendorlan reports tells us *"The school council plays an increasingly active part in the school. Members feel that their suggestions are taken seriously and believe that they have a say in the life of the school."*

Amalgamation would build upon the work that the headteacher, staff and governing bodies have already started in order to improve school standards further. This good work could be more easily built upon; collaboration providing the following potential benefits for pupils standards, enhanced provision, leadership and management:

- creating a shared educational ethos that supports children from age 3 through to 11 and providing consistently high expectations for all
- having both schools phases (Foundation Phase and Key Stage 2) working together with ease to track the children's progress from age 3 to 11
- being able to support a child, knowing them well as learners, from age 3 to 11
- enabling pupils and staff from both Foundation Phase and Key Stage 2 to access specialisms, resources and facilities associated with either phases more easily
- accommodating a wider breadth of activities for more able and talented pupils and those with additional learning needs,
- having a wide range of 'out of school' activities that benefit from greater resources and that could be interest rather than age related
- addressing potential 'dips' in learning that can be associated with transitions and transfers from school to school
- having consistent pastoral care from age 3 to 11
- allowing the community to identify with and support a single primary school and potentially providing a more effective community focus role through a its single governance
- promoting greater interaction allowing opportunities for additional activities which could be supported by parents, children and staff
- reduced duplication and economies of scale in management of budgets
- providing greater opportunities for staff development and learning from new ways of doing things

3.2 Estyn Inspections

Schools are inspected as part of a national programme of school inspection. The purpose of inspection is to identify good features and shortcomings in schools in order that they may improve the quality of education offered and raise the standards achieved by their pupils (*Estyn*).

As a result of changes made in 2010 by Estyn to the inspection criteria schools are evaluated by asking three key questions and awarding judgement based on a four point scale as follows:

Judgement	What the judgement means
Excellent	Many strengths, including significant examples of sector-leading practice
Good	Many strengths and no important areas requiring significant improvement
Adequate	Strengths outweigh areas for improvement.
Unsatisfactory	Important areas for improvement outweigh strengths.

The judgement of the Estyn inspection teams for the schools is as follows:

3.2.1 Ysgol Glan y Mor: Inspected February 2013

Key Questions	Judgement
1 How good are the outcomes?	Adequate
2 How good is provision?	Adequate
3 How good are leadership and management?	Adequate

Estyn revisited Ysgol Babanod Glan y Mor in May 2014 and was judged to have made sufficient progress in relation to the recommendations

1	Improve the quality of pupils' writing	Fully addressed
2	Ensure that teaching and assessment are of a consistently high quality and challenge all pupils to achieve well,	Largely addressed.
3	Strengthen the planning of lessons in order to progressively develop opportunities for pupils to use their numeracy and information communication and technology skills	Fully addressed
4	Increase the effectiveness of self-evaluation and planning for improvement, with a clear focus on outcomes for pupils	Largely addressed.
5	Improve pupils' attendance	Fully addressed.

3.2.2 Ysgol Pendorlan: Inspected September 2011

Key Questions	Judgement
1 How good are the outcomes?	Adequate
2 How good is provision?	Good
3 How good are leadership and management?	Adequate

Estyn revisited Ysgol Pendorlan in November 2012 and was judged to have made sufficient progress in relation to the recommendations

1	Raise standards of attainment in the core subjects	Fully addressed
2	Improve pupils' literacy skills and, in particular, the writing skills of average and less able pupils	Largely addressed
3	Further develop pupils' Welsh language skills	Fully addressed
4	Improve long- term planning for skills development	Fully addressed
5	Ensure a more rigorous approach to self-evaluation	Largely addressed

The proposed amalgamation of the two schools is expected to build upon the good work of the Headteacher, staff and governing bodies in order to provide an opportunity for further improvement.

4. Finance

The average cost per pupil in Conwy is £3,481 with a low of £3,250 in schools with higher pupil numbers and a high of £10,170 in schools with lower pupil numbers. The revenue costs for running Ysgol Babanod Glan y Mor during the 2014/15 financial year were £709,288 with the cost per pupil figure of £4,682. For Ysgol Iau Pendorlan the revenue costs for running the school during the 2014/15 financial year were £735,584 with the cost per pupil figure of £4,431.

One of the drivers for Primary School Modernisation is equality of funding for pupils and through the amalgamation of infants and junior schools the cost per pupil figure for the Colwyn Bay Area will be rationalised. Should the Amalgamation of the two schools take place the cost per pupil would be £4,371.

Capital funding for the scheme has been sourced between the Welsh Government's 21st Century Schools Programme and Conwy County Borough Council's Primary School Modernisation Programme.

There are no capital receipts from the scheme. Recurrent revenue budget savings will be reinvested into the Council's Primary School Modernisation Programme.

5. Condition of School Buildings

Conwy County Borough Council as part of their Asset Management data hold information in relation to the condition of all school buildings (Whole Life Works). They are scored by the following:

A	Serviceable, maintained life with normal maintenance
B	Operational, with minor essential maintenance requirements
C	Operational but with some critical and/or essential maintenance requirement
D	Barely operational, major critical and essential maintenance requirement a risk of breakdown; due for extensive refurbishment or replacement

The scores for each school are detailed below:

Ysgol Glan y Mor	Ysgol Pendorlan
B	B

A similar survey was carried out by EC Harris on behalf of the Welsh Government and their findings reflect those of Conwy County Borough Council.

The existing buildings at Ysgol Babanod Glan y Mor and Ysgol Iau Pendorlan would be used to form the all-through Community Primary School. This will be achieved through the planned building development works to integrate the two sites through the Welsh Government 21st Century Schools Capital funding Programme.

6. Community Impact

Both schools are in a Communities First Area and serve a diverse residential area, including housing association managed flats and homes, rented and owner-occupied housing. Both schools are involved with Community First activities which helps to promote the community focused programme within the Colwyn Bay area for long term sustainability and wellbeing of communities. Should the Proposal to amalgamate the schools proceed, activities and projects such as those listed below would continue and could flourish with the one school and the community first scheme further having an inclusive approach for the future.

Some of the Community First (CF) schemes, activities and projects that both schools are involved which are listed below:-

- Colwyn Bay Heritage project in partnership with the school – pupils and CF developed an activity pack for Colwyn Bay Heritage group
- Joint project with the school to create a Colwyn Bay Football Club mascot
- School have been pro-active in distributing information and promoting CF activities
- CF Knitting project with volunteers knitting with pupils
- Joint CF/ Age Friendly Communities Gardening project at the school.
- CF Publicity event held at school
- Community Consultation (this year) in preparation for the VVP bid (multi agency) at Glan y Mor school.

6.1 Community use of school facilities

Analysis of the 2012/13 and current 2013/14 'Lettings of Premises' returns supplied from the school indicate that Ysgol Iau Pendorlan is used for external weekly dance sessions. There have been no entries from Ysgol Babanod Glan y Mor in the Lettings returns.

Should both schools amalgamate, there is not expected to be any impact on the community use of the school. With developed and improved facilities on the site there could be scope for increased community use in the future.

6.2 Out of School Childcare

Ysgol Babanod Glan y Mor and Ysgol Iau Pendorlan both provide a free WG breakfast to pupils. There is a playgroup operating at the Ysgol Pendorlan site serving pupils aged 3-4 Monday through Friday, 9am to 3pm.

7. Transport Impact

The current Home to School Transport Policy states that free transport will be provided for Primary School pupils who reside over 2 miles from their nearest appropriate school.

There are currently no pupils receiving Home to School Transport to either Ysgol Babanod Glan y Mor or Ysgol Iau Pendorlan that live over 2 miles from the school. The only pupils currently receiving transport to the schools are doing so to attend the current Additional Learning Needs resources that are on site.

Should the Proposal to amalgamate the schools be approved, there will be no changes to the current transport provision. Pupils will continue to receive their education from the same site as they currently do and therefore will not be eligible for free Home to School Transport.

Those pupils who are expected to attend the Foundation Phase and Key Stage 2 ASD units on site will receive transport to those units should they be required to taking into consideration their specific needs and with authorisation from ALN Statementing Officers.

There is no expected impact on available walking routes to the new amalgamated school given that there will be no change in location from current site.

8. Language Impact

The Welsh Government recommends that an analysis of the use of the Welsh Language in the schools referred to in this document is provided.

As the table below demonstrates both Ysgol Babanod Glan Y Mor and Ysgol Iau Pendorlan are English medium schools where all pupils are taught through the medium of English, with less than 25% of the teaching curriculum through the medium of Welsh. Both schools have a mainly English ethos with staff and Governor meetings and pupils' informal activities taking place through the medium of English.

The ESTYN reports for both the schools comments on how Welsh is utilised within the curriculum and in the school as a whole.

Ysgol Babanod Glan y Mor - *"The majority of pupils make good progress in learning Welsh in a variety of situations. Most teachers use Welsh regularly and promote the use of the language well."* (February 2013)

Ysgol Iau Pendorlan - *"Many pupils make very good progress in developing skills in the Welsh language. Pupils' conversational Welsh and their reading skills show appropriate development across key stage 2. Welsh is now far more visible and audible both inside and outside the classroom."* (November 2012)

The proposal to formally amalgamate Ysgol Babanod Glan y Mor and Ysgol Iau Pendorlan will not impact negatively on the use of the Welsh Language, by having one Governing Body there is expected to be opportunity to work towards improving how the Welsh Language is promoted and expanded through the curriculum and in more informal activities.

Analysis of the use of Welsh Language	Ysgol Babanod Glan y Mor	Ysgol Iau Pendorlan
Pupil Numbers – Full and Part Time (as at January 2014)	177	165
Language category of the school	English Medium	English Medium
(PLASC 2014) Percentage of pupils from homes where the language spoken is:		
<i>Does not speak Welsh at Home</i>	9%	7%
<i>Speaks Welsh at Home</i>	7%	8%
<i>Not applicable, cannot speak Welsh</i>	84%	85%
Percentage <u>taught</u> through the medium of Welsh	0%	0%
Percentage of children that <u>received</u> a Teacher Assessment in Welsh at the end of		
<i>Foundation Phase</i>	0	N/A
<i>Key Stage 2</i>	N/A	0
Of those that received a Teacher Assessment in Welsh, the percentage of children that <u>achieved</u> at		
<i>Foundation Phase</i>	N/A	N/A
<i>Key Stage 2</i>	N/A	N/A
Pupils language medium in the		
<i>Playground</i>	English	English
<i>Breakfast Club</i>	English	English
<i>After-school club</i>	English	English
(Sept Stats 13) School participates annually in:		
<i>Cylch Meithrin / Ti a Fi</i>	No	No
<i>Eisteddfodau</i>	No	No
<i>Urdd Branches</i>	No	No
<i>Other Welsh Medium activities</i>	No	Yes

The school is used by the community to learn Welsh	No	No
Percentage of Teaching staff able to teach through the medium of Welsh:	10%	18%
Percentage of Support Staff that are able to teach through the medium of Welsh:	7%	0%
Percentage of Governors that are able to speak Welsh:	7%	7%
Language most commonly used during: <i>Governor meetings –</i> <i>PTA meetings</i> <i>Staff meetings</i>	English English English	English English English
(of persons aged 3+) The percentage of the Local Ward that: <i>Speak Welsh</i>	Glyn	Glyn
<i>No skills in Welsh</i>	19.7%	
	68.6%	

9. Equality Impact

The below tables consider the existing information of the 2 schools in relation to any specific equality strands that may need to be considered during the implementation of the proposals. The information for the 2 schools shows a diverse school population and there is no indication that any pupils would be disadvantaged should the proposal to formally amalgamate the 2 schools go ahead; given that they will both remain on the same site and pupils will have little change in their daily school routine.

The ESTYN Inspection reports for both Ysgol Babanod Glan y Mor and Ysgol Iau Pendorlan demonstrate that the schools have a safe and inclusive environment for pupils that would continue should the schools formally amalgamate.

Ysgol Babanod Glan y Mor's ESTYN report from 2013 states that *"The school is a calm and orderly community, with a friendly and supportive atmosphere that ensures pupils feel safe and well supported. The school encourages pupils to work well together and to show respect, care and concern for others. There are good arrangements in place to support pupils' wellbeing and healthy lifestyles. Learning experiences promote pupils' personal development well, including their spiritual, moral, social and cultural development. The recently established nurture club provides very effective support for vulnerable pupils."*

The findings of the Ysgol Iau Pendorlan ESTYN inspection from 2011 tell us that *"All feel safe in school and say that little bullying or harassment occurs. The behaviour of nearly all pupils is good both within classes and at break and lunchtimes. Nearly all are polite, courteous and show respect for each other. This is reflected in their positive and generally enthusiastic attitude to learning. Provision for pupil' spiritual, moral, social and cultural development is good. Good behaviour is promoted effectively and pupils are encouraged to take responsibility for their own actions."*

Equality Strand	Ysgol Babanod Glan y Mor
Race	<p>(PLASC 2014) In Ysgol Babanod Glan y Mor 83% of its pupils who are over 5 years old are 'White British'. The remaining 17% of pupils include 'Bangladeshi' 'Pakistani' ' Nepali' 'Other Chinese', ' Asian & any other Ethnic group', 'White & Asian', 'White & Black Caribbean', 'White & Chinese' and 'Afghanistani'.</p> <p>The 2014 PLASC return also tells us that 48% of Ysgol Glan y Mor's pupils are of 'British' nationality, 37% are 'Welsh', 10% 'English' and 3% 'Other'.</p> <p>Information in relation to race is regarded as 'sensitive data' and as such, the information for pupils under the age of 5 is withheld.</p>
Disability	<p>(PLASC 2014) There are currently around 27% of pupils at Ysgol Babanod Glan y Mor who receive some support for Additional Learning Needs. Of these, around 75% are boys and 25% are girls.</p> <p>Ysgol Babanod Glan y Mor's ESTYN report tells us that "The school successfully identifies pupils' additional learning needs early. There are good quality programmes in place to support these pupils."</p>
Gender	<p>(PLASC 2014) Of the 126 pupils who currently attend school full time at Ysgol Babanod Glan y Mor there are 63 boys and 63 girls.</p> <p>In order to establish whether boys or girls perform any better than each other we can look at data at a school level, which can then be compared to data given on a Conwy County level and an All Wales level.</p> <p>In the May 2014 Foundation Phase Indicator (FPI) Assessments Girls outperformed Boys at School, County and National level. Girls at Ysgol Babanod Glan y Mor achieved higher results than their County and National counterparts. Conversely Boys at Ysgol Babanod Glan y Mor did not perform as well compared to both County and National results.</p>

Age	Ysgol Babanod Glan y Mor is an infant's school providing full time education for pupils aged 4-7 and part time nursery for pupils aged 3-4 years old. Information classed as 'sensitive' e.g. ethnicity, nationality, is not reported for children under 5 years of age, in line with National recommendations.
Religion & Belief	(PLASC 2014) Ysgol Babanod Glan y Mor is not an affiliated denominational school, which is reflected in the breakdown of pupil's religious beliefs. At Ysgol Glan y Mor 60% of pupils are recorded as having 'No Religion'. and 20% 'Christian'. The remaining 20% consist of 'Anglican', 'Baptist', 'Buddhist', 'Hindu', 'Methodist', 'Muslim', 'Other' and 'Roman Catholic'. The report from the school's last Estyn Inspection in 2013 makes the comment that <i>"The school encourages pupils to work well together and to show respect, care and concern for others. Learning experiences promote pupils' personal development well, including their spiritual, moral, social and cultural development."</i>
Sexual Orientation	N/A
Welsh Language	See 'Language Analysis' for Ysgol Babanod Glan y Mor (Section 8)
Other (please state)	(PLASC 2014) There are around 46% of pupils who attend Ysgol Babanod Glan y Mor that are currently eligible for free school meals.

Equality Strand	Ysgol Iau Pendorlan
Race	(PLASC 2014) In Ysgol Iau Pendorlan 86% of its pupils are 'White British', and the remaining 14% were 'Bangladeshi' ' Nepali' 'Other Chinese', 'Asian & Chinese', 'Chinese & any other Ethnic group', 'White & Asian' 'White & Black African', 'White & Black Caribbean', 'Other White', 'Polish', 'Information Not Obtained', and 'Information Refused'. The PLASC 2014 data tells us that 49% of pupils are 'British' 39% 'Welsh', 6% are 'English' and the remaining 6% are 'Irish' and 'Other'.
Disability	(PLASC 2014) There are currently around 38% of pupils who receive some support for additional learning needs, around 12% of these have a statement of special needs. Of those pupils who receive support at Ysgol Iau Pendorlan 24% are Boys and 10% are Girls.
Gender	(PLASC 2014) Of the 165 pupils who currently attend Ysgol Iau Pendorlan there are 93 Boys and 72 Girls. In order to establish whether boys or girls perform any better than each other we can look at data at a school level, which can then be compared to data given on a Conwy County level and an All Wales level. In the May 2014 Key Stage 2 Assessments – Core Subject Indicators (CSI) showed that Girls outperformed Boys at School level. In comparison to County and National averages both girls and boys at Ysgol Iau Pendorlan marginally underperformed.
Age	Ysgol Iau Pendorlan is a junior school providing education for pupils aged 7 to 11. As at PLASC 2014 there are 41 pupils aged 7, 33 pupils aged 8, 53 pupils aged 9 and 38 pupils aged 10.
Religion & Belief	(PLASC 2014) Ysgol Iau Pendorlan is not an affiliated denominational school, which is reflected in the breakdown of pupil's religious beliefs. At Ysgol Pendorlan 50% of pupils are recorded as having 'No Religion' and 32% 'Christian'. The remaining 18% consist of 'Anglican', 'Buddhist', 'Hindu', 'Methodist', 'Muslim', 'Other', 'Refused' and 'Roman Catholic'.

	The report from the school's last Estyn Inspection in 2011 makes the comment that <i>"Provision for pupil' spiritual, moral, social and cultural development is good. Good behaviour is promoted effectively and pupils are encouraged to take responsibility for their own actions."</i>
Sexual Orientation	N/A
Welsh Language	See 'Language Analysis' for Ysgol Iau Pendorlan (Section 8)
Other (please state)	(PLASC 2014) There are around 30% of pupils who attend Ysgol Iau Pendorlan that are currently eligible for free school meals.

10. Children's Workshops

In September 2013 officers from Education Services met with pupil representatives from both the school councils of Ysgol Babanod Glan y Mor and Ysgol Iau Pendorlan to discuss the proposed amalgamation of the two schools.

A presentation was shown to the pupils explaining the proposed amalgamation and what it would mean for them (example slide shown below). All pupils were very aware of the proposed changes and were enthusiastic with their questions and ideas.

Some of the questions raised by pupils included – What would join the 2 schools? When will it start? Will they be allowed time off school? How would dinner time be sorted out? Would the school council decide on a new school name/uniform?

All the pupils were in agreement that they would like a bigger playground area with shelters for the winter. Older pupils in the group raised queries about there being enough facilities for the younger pupils if there were to be an amalgamated school.

Further consultation with pupils in relation to the Proposal will be undertaken as part of the formal Statutory Processes.

What this means

Both Ysgol Glan y Mor and Ysgol Pendorlan will stay in the same place

1 Headteacher & Teachers



1 Governing Body

There will be some building work



The school will have a new name

New Name

Governing Body 

Pennaeth Head Teacher

11. Consultation

This document marks the start of the consultation. This enables all interested parties to give their views on the proposal before any statutory notices are published. This period of consultation will last until the 18th November 2014. As mentioned above, a meeting for Stakeholders will be held on Thursday 23rd October from 5pm at Ysgol Glan y Mor. The Council will consider carefully any comments made at the meeting and all comments and observations made in writing by this date. As a result of the consultation the Council may decide not to proceed any further with the proposal or to go ahead with the proposal or a modified version of it. Any formal proposal would be set out and published in the form of a public statutory notice.

The Council has the powers to propose expansions or closures of schools. If proposals are published following this period of consultation, there then follows a statutory 28 day period during which further representations and formal objections can be made.

Any responses during the Consultation will not be regarded as formal objections. To have responses considered as statutory objections they must be made in writing or by email within the 28 day objection period.

Whether or not objections are received within the statutory period, the proposal will be determined by the Authority at the end of the 28 day objection period.

How can you comment on the proposal?

- By attending and speaking in the Stakeholder meeting
- By attending the Stakeholder meeting and handing in your written comments and observations
- By filling in the attached questionnaire and sending it to Richard Ellis Owen, Head of Education (Chief Education Officer), Education Department, Government Buildings, Dinerth Road, Colwyn Bay LL28 4UL
- Those requiring an electronic and/ or Welsh copy can e-mail School.Modernisation@conwy.gov.uk
- By writing to Richard Ellis Owen, Head of Education (Chief Education Officer), Education Department, Government Buildings, Dinerth Road, Colwyn Bay LL28 4UL
- By e-mailing your views to School.Modernisation@conwy.gov.uk .
- If at the end of the consultation period the Council decides to proceed with the proposal, by submitting a written objection during the Statutory Objection Period. The statutory objection period will be advertised.

**Proposal for the Amalgamation of
Ysgol Babanod Glan y Mor
and
Ysgol Iau Pendorlan**

PLEASE RETURN NO LATER THAN 18th NOVEMBER 2014

To: Richard Ellis Owen, Head of Education Services (Chief Education Officer),
Education Department, Government Buildings, Dinerth Road, Colwyn Bay LL28 4UL

Fax: 01492 541311

You can also email your views to: School.Modernisation@conwy.gov.uk

Do you agree with the proposal to amalgamate Ysgol Babanod Glan y Mor and Ysgol Iau Pendorlan?

Yes No

I am:-

The parent of a child currently at one of the above schools

The parent of a child previously at the school The parent of a child at another school

A member of staff at the school A member of staff at another school

A governor of the school A governor of another school

Other interested party Name of other school or interested party _____

My comments are as follows:

Do you wish to receive notification via email link of the Consultation Report once published on Conwy County Borough Council Education Services webpage?

Yes No

If 'Yes' please provide email address: _____